

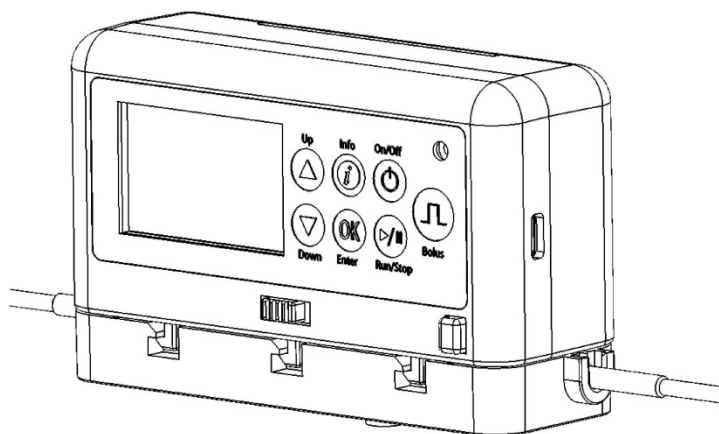

Safe, sleek & simple infusion for *superior analgesia*

Nimbus™ II PainPRO Ambulatory Infusion Pump

Patient Manual



PCA Mode Infusions

Read this entire manual prior to operating the Nimbus™ II PainPRO Ambulatory Infusion

Table of Contents



Section 1: General Description.....	3
Indications for use.....	3
Warnings.....	5
Device Diagrams.....	7
Keypad Diagram.....	8
LCD Screen Symbols.....	9
Section 2: Your Nimbus™ II PainPRO Ambulatory Infusion Pump.....	10
Upper Extremity Blocks:.....	10
Lower Extremity Blocks:.....	10
Get familiar with your Nimbus™ II PainPRO Ambulatory Infusion Pump:.....	11
Infusion Mode.....	11
Pause Mode.....	11
Options:.....	12
Pump Set Up and Programming.....	12
Section 3: Operating your Pump.....	13
Start or Resume the Infusion.....	13
Cancel a Delay Start.....	13
Demand Bolus – (if enabled).....	14
Stop or Pause the Infusion.....	14
Acknowledge an Alert.....	14
Infusion Complete.....	15
Power off the Pump.....	15
Power the Pump back on and Resume the Infusion.....	15
Pack and Wear Pouch.....	16
Section 4: Troubleshooting.....	17
Section 5: Battery Replacement.....	19
Authorized Battery.....	19





Section 1: General Description

Indications for use

The Nimbus™ II PainPRO Ambulatory Infusion Pump is intended to deliver medications and/or fluids to a patient under the direction or supervision of a physician or other certified healthcare professional in clinical or nonclinical environments, such as homes. The device is intended for subcutaneous, percutaneous, perineural, epidural and intravenous infusion, including but not limited to patient controlled analgesia (PCA) delivery.

Symbols

Symbol	Standard	Reference number and title of symbol	Description of symbol
	ISO 15223-1:2012 Medical devices -- Symbols to be used with medical device labels, labelling and information to be supplied -- Part 1: General requirements	5.4.3 Consult instruction for use	Indicates the need for the user to consult the instructions for use.
	ISO 15223-1:2012 Medical devices -- Symbols to be used with medical device labels, labelling and information to be supplied -- Part 1: General requirements	5.4.4 Caution	Indicates the need for the user to consult the instructions for use for important cautionary information such as warnings and precautions that cannot, for a variety of reasons, be presented on the medical device itself.
	IEC 60417:2002 DB Graphical symbols for use on equipment	5333 Type BF applied part	To identify a type BF applied part complying with IEC 60601-1.

Symbol	Standard	Reference number and title of symbol	Description of symbol
	ISO 15223-1:2012 Medical devices -- Symbols to be used with medical device labels, labelling and information to be supplied -- Part 1: General requirements	5.3.4 Keep dry	Indicates a medical device that needs to be protected from moisture.
	ISO 15223-1:2012 Medical devices -- Symbols to be used with medical device labels, labelling and information to be supplied -- Part 1: General requirements	5.3.2 Keep away from sunlight	Indicates a medical device that needs protection from light sources.
	ISO 15223-1:2012 Medical devices -- Symbols to be used with medical device labels, labelling and information to be supplied -- Part 1: General requirements	5.3.7 Temperature limit	Indicates the temperature limits to which the medical device can be safely exposed.
	ISO 15223-1:2012 Medical devices -- Symbols to be used with medical device labels, labelling and information to be supplied -- Part 1: General requirements	5.1.7 Serial number	Indicates the manufacturer's serial number so that a specific medical device can be identified
Rx Only	N/A	Prescription only	Federal (U.S.A) law restricts this device to sale by or on the order of a physician.

Note: A Note highlights information that helps explain a concept or procedure.

Caution: Indicates a potentially hazardous situation which, if not avoided, may result in minor or moderate injury or product damage.

Warnings

A warning (⚠) alerts you to a condition that could potentially interrupt the medication delivery.

- ⚠ Read the entire Patient’s Manual prior to operating the Nimbus™ II PainPRO Ambulatory Infusion Pump. InfuTronix assumes no responsibility for incidents that may occur if its product is not used in accordance with its product labeling.
- ⚠ Only use the pump as directed by a physician or other certified health care professional.
- ⚠ If you have any questions regarding the use of the pump or experience any problems using the pump, contact your anesthesia care team for further instructions.
- ⚠ Do not use the pump in or near a MRI (Magnetic Resonance Imaging) device.
- ⚠ If the pump is dropped, inspect it for damage before continuing the infusion. Stop using the pump and call your anesthesia care team if it is damaged or is not functioning properly.
- ⚠ There are no user serviceable parts inside. Refer all service, repair, and calibration to qualified technical personnel. Do not make unauthorized modifications.
- ⚠ The Nimbus™ II PainPRO Ambulatory Pump and cassette/administration set should only be manipulated and/or operated by a patient or caregiver under the direction or supervision of a physician or other certified health care professional
- ⚠ If a patient or caregiver is to operate the Nimbus II Ambulatory Infusion pump without the direct supervision of a medical professional, the patient or caregiver should have the means to contact the patient’s health care provider at all times.
- ⚠ If the Nimbus™ II PainPRO Ambulatory Infusion pump is used to provide medication or fluid therapy to any patient under the age of 18, that patient should, during therapy and while having physical access to the pump and administration set, be under the direct supervision of a physician or other certified health care professional or an adult caregiver trained by a medical professional to operate the pump.
- ⚠ Only use InfuTronix approved cassettes/administration sets with the pump.
- ⚠ Before packaging the drug/fluid bag and pump into the pouch, check the fluid path for kinks, closed clamp or other occlusions.
- ⚠ Clamp the administration set before removing the cassette from the pump.

Warnings, continued

- ⚠ Avoid spills on the Nimbus II ambulatory pump; consult your health care provider should this occur.
- ⚠ If the pump is dropped or hit, inspect the pump for damage. Immediately stop using the pump if it is physically damaged or not functioning properly. Contact distributor to return the pump.
- ⚠ Small objects may cause choking if swallowed. Keep all small parts and objects away from children.

Device Diagrams

Front View

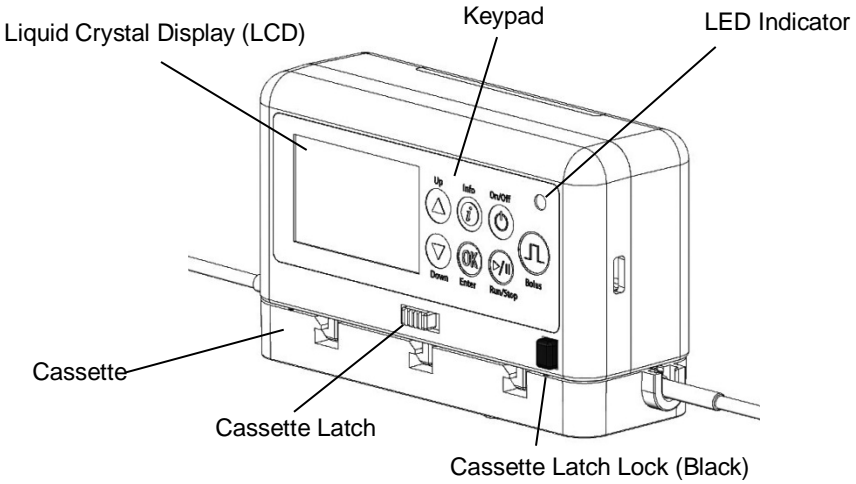

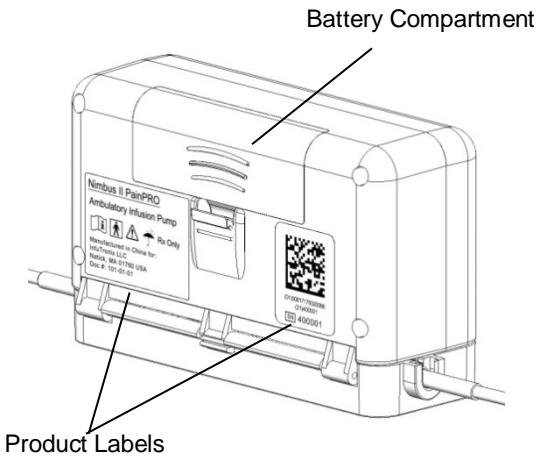

Rear View



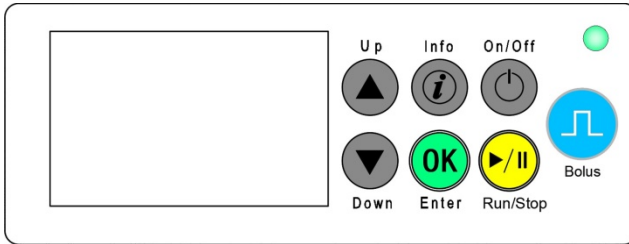









Keypad Diagram



Key	Name	Description
 Run/Stop	RUN/STOP	Press to start or resume the infusion. Press and hold for 3 seconds to pause the infusion.
 On/Off	ON/OFF	Press and hold the ON/OFF key for 3 seconds to power on or off the device.
 Bolus	BOLUS	Press to request a patient demand bolus or hold for 3 seconds to cancel a delayed infusion start

Note: The pump has additional functions beyond those shown above. These functions are intended to be used by medical professionals only. Do not attempt to use these functions unless specifically instructed to do so and trained to do so by a physician or other certified healthcare professional.

LCD Screen Symbols

Item	Name	Symbol	Description
1	Therapy Mode		The symbol displays when the pump is infusing.
2	Configuration Mode		The pump is in configuration mode.
3	Programming Lockout		Clinician code is required to change parameter values.
			No clinician code needed to change parameter values.
4	Battery Level Indicator		The symbol indicates a full battery level.
			The symbol indicates a medium battery level.
			The symbol indicates a low battery level.
			The symbol indicates an empty battery level.
5	Alert		The symbol will display if an alert condition is present.
6	Setting		The pump is in the setting mode.
7	Pause		The pump is in Pause mode.

Note: This table includes references to functions that are intended to be used by medical professionals only. Do not attempt to use these functions unless specifically instructed and trained to do so by a physician or other certified healthcare professional.

Section 2: Your Nimbus™ II PainPRO Ambulatory Infusion Pump

Your surgeon has prescribed a Nimbus™ II PainPRO Ambulatory Infusion Pump to assist you with your pain management needs after surgery. The PainPRO is an electronic pump that delivers a **numbing** medication, **not a narcotic**, to the nerves that control the feeling and movement to the area where you had surgery. The medicine delivered by the Pump **will not** make you feel drowsy, nauseated, or dizzy, allowing you to feel better **faster**, resume normal activities **sooner**, and have the potential for a **quicker** recovery. Since the surgical extremity **will be numb** (decreased sensation), it is at greater risk of injury. The following safety precautions are recommended to reduce the risk of injury and provide a more pleasant surgical experience.

Upper Extremity Blocks:

- Support your arm by wearing a sling properly; ensuring your wrist is fully supported.
- Use a pillow to pad and support your numb extremity.
- Avoid placing hot or cold packs directly on your numb extremity.
- If a dressing, cast, or brace is provided, check your fingernails frequently and alert your surgeon of any change in color.



Lower Extremity Blocks:

- Use crutches or a walker since you will **not be** able to bear weight on the numb extremity. After full sensation returns, follow your surgeons' weight bearing instructions.
- If a knee brace is provided, **do not** attempt to walk without it.
- Check your toenails frequently and **alert your surgeon** of any change in color.
- The numb extremity should be carefully padded and routinely repositioned. This practice will promote good circulation.



If shortness of breath, ringing in the ears, or a metallic taste in your mouth occurs, turn the pump off immediately and contact your anesthesiologist

Get familiar with your Nimbus™ II PainPRO Ambulatory Infusion Pump:

Infusion Mode

When the pump is infusing medication, there will always be information available on the screen to assure you that the pump is functioning properly.

- The LCD will display the infusion rate in mL/Hr at the center of the screen.
- The medication bag symbol  will display while the pump is infusing your medication.
- A green LED light will show at the top right corner of your pump indicating the infusion is running then will turn off after 10 minutes to save battery power.
- After any button press the green LED will turn on again for 10 more minutes to inform you the infusion is delivering and then power off. This is normal.

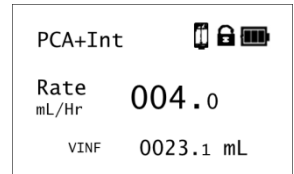





Along the bottom of the screen, additional information is displayed about your infusion:

- The letters “VTBI” followed by a number will tell you the remaining Volume To Be Infused (VTBI) before the therapy ends.
- The letters “VINF” followed by a number will tell you how much medication has been infused so far during your infusion.
- “Next AB” followed by a time will indicate when the next Auto-Bolus dose is scheduled to be infused.
- “Next DB” followed by a time will indicate the lockout time remaining before the next Demand Bolus dose will be allowed.
- From time to time you may hear a sound as the motor turns to infuse the numbing medication.

Pause Mode

If the fluid bag icon is missing from the display and a yellow LED light is showing, these signals indicate that the pump is in pause mode and is not infusing medication. If after 10 minutes the infusion is not resumed, the pump will sound an audible alert and the screen will display a “Pump Unattended” message to tell you it is in standby mode waiting to be told what to do next.

Options:

- Press the RUN/STOP  key to silence the alert and return to the main programming screen.
- To resume your infusion press and release the RUN/STOP  key again to perform an automatic review of the prescription.
- Press the OK  key to confirm the prescription and begin the infusion.
- Or, to turn the pump off press and hold the ON/OFF key  for 3 seconds.

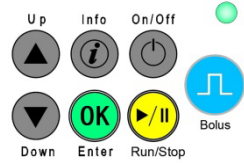

Pump Set Up and Programming

The Nimbus™ II PainPRO Ambulatory Infusion Pump should be set up and programmed by a member of your anesthesia care team. Do not attempt to perform any of these functions unless specifically instructed and trained to do so by a member of your anesthesia care team.

Your pump can be programmed to infuse the local anesthetic using any combination of the following methods:

Basal Rate – A continuous, low-volume infusion of medication.

Bolus – A bolus is a dose of medicine that is delivered quickly to help relieve your pain. A bolus can be programmed to function 2 different ways:

Demand Bolus –When enabled, a patient can press the BOLUS key to request an extra “bonus” dose of numbing medicine for rapid pain relief.



Auto Bolus – is a bolus that is scheduled to infuse repeatedly over a preset period of time.

Delayed Infusion Start – If the pain after your surgery is expected to last several days, a delay start can be programmed to extend the duration of your therapy up to 24 hours longer without adding extra medicine to the IV bag.

If a delay start is activated, the pump will automatically begin infusing the medicine when the timer counts down to zero. Additionally, you will be instructed on how to cancel the timer and start your infusion immediately if you begin to feel the post-surgical pain.

Section 3: Operating your Pump

Start or Resume the Infusion

To start the infusion, press the RUN/ STOP  key. A fluid bag icon  will be displayed on the screen to indicate the infusion is running; The LED will show a green light and will be on for 10 minutes, then the LED will turn off until the next key press.

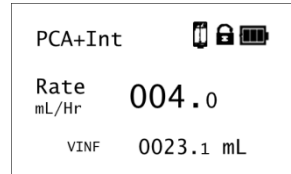

Cancel a Delay Start

If a delay start is set to run at the beginning of your therapy, a countdown timer will be displayed on the screen to show the time that remains before the pump automatically starts the infusion. If your pain is at a tolerable level after the surgery, the pump will count down to zero and start the infusion without any action from you. However, if during the delay period you start to feel uncomfortable due to the pain, you can choose to override the Delay Start feature to begin the infusion immediately.

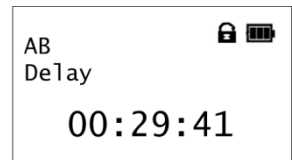

As instructed by your support team, press and hold the BOLUS  key for 3 seconds to cancel the delay timer.

- The delay countdown will be cancelled.
- The pump immediately starts the infusion as set by your anesthesia care team.

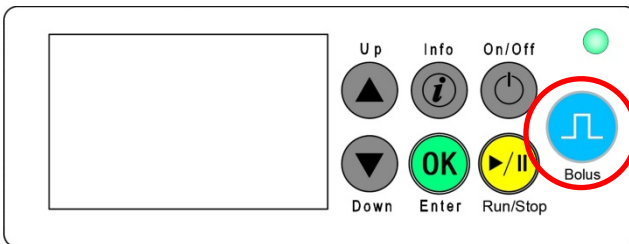

Demand Bolus – (if enabled)



If you experience pain during the infusion, you can press the blue Bolus key to request an extra (**bolus**) dose of numbing medication. If allowed in your prescription, a bar displays on the screen to countdown the Bolus volume indicating the medicine is being delivered.

Stop or Pause the Infusion





If at any time you want to stop the infusion, hold the RUN/STOP key  for 3 seconds and the infusion will be paused until further action is taken.

- The LED light will turn amber.
- The therapy mode sign  will disappear from the display screen to be replaced by a pause icon, indicating that the infusion has been stopped.

If no action is taken to resume the infusion or power off the pump, after 10 minutes an alert will sound to indicate the pump is on but not infusing medicine.

- Press the RUN/STOP key  to silence the alert and return to the main programming screen.
- To resume your infusion press and release the RUN/STOP key again beginning an automatic review of the prescription.

- Press the OK key  to confirm and begin the infusion.
- Or, to turn the pump off press and hold the ON/OFF key  for 3 seconds

Acknowledge an Alert

If at any time during an infusion the pump senses a condition that could interrupt the medication delivery, an alert message will be displayed on the LCD screen along with a red flashing LED light. An audible alert may also sound.



Press the RUN/STOP key  to acknowledge the condition and silence the audible alert. Contact your healthcare provider for further instructions.

Infusion Complete

Your infusion will be complete on the day indicated by your anesthesiologist or when the pump is empty, whichever happens first. If the bag runs until empty, the LCD screen displays the message shown on the right, indicating that the end-of-infusion has been reached. The audio alert will sound three beeps and the LED flashes a red light. The alert symbol will also display on the screen.







Press the RUN/ STOP key  to acknowledge the condition and silence the audio alert. Follow the instructions given to you by your anesthesia care team regarding the steps to follow at the end of your therapy.

Power off the Pump

Press and hold the ON/OFF key  for 3-seconds to power off the pump.

Power the Pump back on and Resume the Infusion:

- Hold  for 3 seconds to power on the pump.
- Highlight Current Rx then press  to advance.
- Press  to select Resume Infusion.
- Press  initiating a review of the prescription, and then press  to confirm and resume the infusion.

Pack and Wear Pouch

⚠ Warning: Before packaging the drug/fluid bag and pump into the pouch, check the fluid path for kinks, closed clamp or other occlusions. An undetected occlusion may result in under-infusion or non-delivery of medication and cause an undesirable pain relief outcome.

Open the pump pouch and place it flat on a table.

Open the Velcro strap, position the pump against the clear window with the display screen facing out, and then close the Velcro straps tightly to hold the pump securely in the window.

Place the drug/fluid bag in the bag chamber with the bag spike pointing left. Fold the bag spike over the top of the medicine bag and route the upstream end of the tubing between drug/fluid bag and pump carefully so that the tubing does not have kinks or occlusions.

Route the downstream end of the tubing carrying fluid to the patient through the tubing outlet. Close the pouch cover and zip closed.

Secure the pouch around the patient's waist or over the patient's shoulder. The carry strap may be adjusted for size.

Caution: Leave the pump inside the carry pouch at all times except for programming, loading and unloading the cassette/administration set, or troubleshooting.

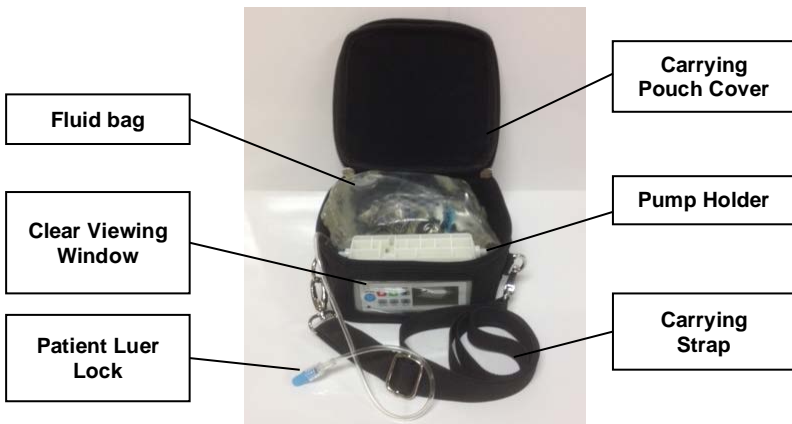

Section 4: Troubleshooting

When a condition is detected by the pump that could interrupt the infusion, the pump will alert with an audio and visual signal to indicate the presence of the condition. If this occurs, contact your anesthesia care team for support.

Note: The following table is included for reference only. You can press the RUN/STOP key to acknowledge the condition and silence the audible tone. Do not attempt to perform other functions unless specifically instructed to do so by a member of your support team.

Alert Message	Indication	Signal
Cassette Loading Error	The cassette may not be attached properly or has become dislodged. Note: <i>The infusion will be stopped.</i>	The screen displays “Cassette Loading Error”; the LED flashes a red light; the audio alarm sounds.
Upstream Occlusion	A decrease in pressure is sensed in the supply line between the pump and medication bag. Note: <i>The infusion will be stopped.</i>	The screen displays “Upstream Occlusion”; the LED flashes a red light; the audio alert will sound after 3 minutes if the upstream occlusion is not resolved. Note: <i>When resolved, the infusion will resume automatically.</i>
Downstream Occlusion	An increase in pressure is detected in the line between the pump and the patient’s catheter. Note: <i>The infusion will be stopped.</i>	The screen displays “Downstream Occlusion”; the LED flashes a red light; the audio alert will sound after 15 minutes, if the downstream occlusion is not resolved. Note: <i>When resolved, the infusion will resume automatically.</i>
Pump Unattended	The pump is standing by and not infusing for more than 10 minutes.	The screen displays “Pump Unattended”; the LED shows a solid yellow light; the audio alert sounds. Follow instructions on pg. 13 to acknowledge an alert. Note: <i>The audible alarm will return after 10 minutes if no further action is taken after acknowledging the condition.</i>

<p>Infusion Complete</p>	<p>The infusion is completed.</p>	<p>The screen displays “Infusion Complete”; the LED flashes a red light; the audio alert sounds.</p> <p>Follow the instructions on pg. 14 to silence the alert and power off the pump.</p>
<p>Battery Depleted</p>	<p>The infusion will continue for 30 minutes prior to shutting down.</p>	<p>The screen displays “Battery Depleted” for 5 seconds and repeats displaying every 20 seconds; the empty battery level indicator symbol flashes; the LED shows a solid yellow light; the audio alert sounds.</p> <p>Follow the instructions on pg. 18 to replace the battery and resume the infusion.</p>
<p>Power Off and Replace Battery</p>	<p>This battery has been used for over 240 hours /infusion volume has reached 1500 mL. The pump has reached the end of its performance life.</p>	<p>The screen displays “Power Off and Replace Battery”, the LED flashes a red light; the audio alert sounds.</p> <p>Follow the instructions on pg. 14 to silence the alert and power off the pump. Contact your anesthesia care team for further instructions.</p>
<p>Invalid Infusion Parameter</p>	<p>An infusion parameter has been entered that exceeds the remaining pump life.</p>	<p>The screen displays “Invalid Infusion Parameter”; the LED flashes a red light; the audio alert sounds.</p>
<p>System Error</p>	<p>The pumping mechanism may not work properly.</p> <p>Note: <i>The infusion will be stopped.</i></p>	<p>The screen displays “System Error”; the LED flashes a red light; the audio alarm sounds.</p>
<p>Firmware Error</p>	<p>The system fails to operate in a controlled fashion.</p> <p>Note: <i>The infusion will be stopped.</i></p>	<p>The screen displays “Firmware Error”; the LED flashes a red light; the audio alarm sounds.</p>

<p>Max Vol Reached, Pump Standby</p>	<p>The pump has reached a maximum volume per hour or interval limit.</p>	<p>The screen displays “Max Vol Reached, Pump Standby” until the new hour or interval is reached when the infusion can begin again; the LED shows a solid yellow light.</p> <p>Note: <i>The infusion will be stopped automatically.</i></p>
--------------------------------------	--	--

Section 5: Battery Replacement

The battery should be replaced if the pump alerts the user and displays the message “Battery Depleted”.

Authorized Battery

 Only use batteries authorized by the manufacturer.

The quality of the battery is a significant factor in determining battery life and runtime. Use of batteries from any other brands may yield unexpected performance and will invalidate the warranty.

To replace the battery:

Please contact your anesthesia care team for battery replacement.

How to Load the Cassette

1. Engage the cassette “fingers” with the pump hinge.

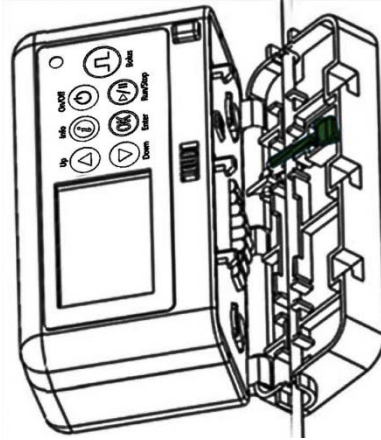

2. Press the cassette latch lock down and firmly push the cassette towards the pump.

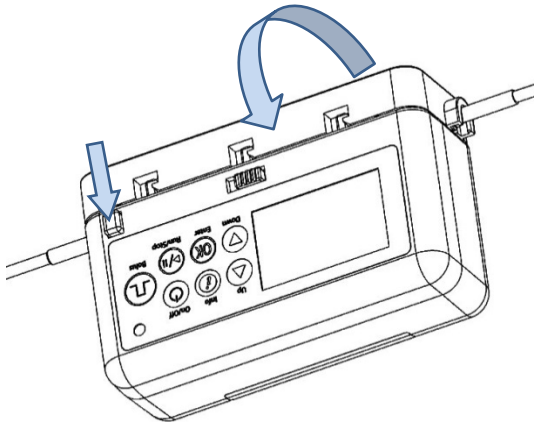

3. Release the cassette latch lock.

4. Confirm that the 3 hooks on the cassette latch are fully engaged with the cassette.

This page is intentionally left
blank.

This page is intentionally left
blank.

This page is intentionally left
blank.

What Should You Expect Going Home with a Nimbus™ Pump?

- When the pump is running there will always be information available on the screen to reassure you it is functioning properly.
- A fluid bag icon will display on the screen for as long as the medicine is infusing.
- Your surgical pain should be controlled but may not be completely eliminated.
- The Nimbus™ pain pump does not replace your pain medication after surgery. If you continue to experience pain, you can take your pain medications as prescribed. If the pain persists, contact your anesthesiologist.
- On the day of the surgery the surgical extremity will be extremely numb. On the days that follow, the extremity will be less numb. This is normal. If the sensation has not returned to normal 14 days following a nerve block, contact your anesthesiologist.

**InfuTronix LLC
177 Pine Street
Natick, MA 01760**

**Email: info@infutronix.com
www.infutronix.com**

